

Installation Support • Soporte de instalación • Support d'installation

Personal Assistance, Product Specs, &
"How-to" Questions:

Asistencia personal, especificaciones del producto y preguntas sobre "cómo hacerlo":

Aide personnelle, spécifications du produit et questions « pratique-pratiques » :

1-800-340-7608

www.pfisterfaucets.com/international



WARNING / ADVERTENCIA / AVERTISSEMENT

To reduce the risk of injury or property damage, read all instructions before installing product. Wear safety goggles. Product must be installed in accordance with all state & local plumbing & building codes. Call a professional if you are uncertain about installing this product.

Para disminuir el riesgo de lesiones o daños a la propiedad, lea todas las instrucciones antes de instalar el producto. Utilice gafas de seguridad. El producto deberá instalarse de acuerdo con la normativa de plomería y construcción estatal y local. Llame a un profesional si no está seguro sobre cómo instalar este producto.

Pour réduire le risque de blessures ou de dommages, lire toutes les instructions avant d'installer le produit. Porter des lunettes de sécurité. Le produit doit être installé en conformité avec tous les codes de construction et de plomberie locaux et de l'état. Appelez un professionnel si vous n'êtes pas certain de la façon d'installer ce produit.

Required Tools

Herramientas necesarias

Outils nécessaires



Adjustable Wrenches
Llaves ajustables
Clés à mollette



Safety Goggles
Anteojos de seguridad
Lunettes de sûreté

Additional Helpful Tools

Otras herramientas útiles

Outils supplémentaires utiles

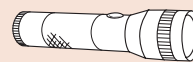

Flashlight
Linterna
Lampe De Poche



Cloth
Paño de limpieza
Chiffon

Parts in the Box

Piezas en la caja

Pièces dans la boîte

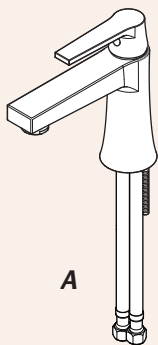

1 Turn Off Water Supply • Cierre el suministro de agua • Couper l'alimentation en eau



Locate water supply inlets and shut off the water supply valves. These are usually found under the sink or near the water meter. If you are replacing an existing faucet, remove the old faucet from the sink and clean the sink surface thoroughly.

Ubique las entradas del suministro de agua y cierre las válvulas de suministro de agua. Generalmente se encuentran debajo del fregadero o cerca del medidor de agua. Si se trata de un reemplazo de grifo, quite el grifo viejo y limpie completamente la superficie del fregadero.

Recherchez les entrées d'approvisionnement et fermer leurs robinets. Ces robinets se trouvent généralement sous l'évier ou près du compteur d'eau. Si vous remplacez un robinet existant, retirez, le vieux robinet de l'évier et nettoyer soigneusement la surface de ce dernier.

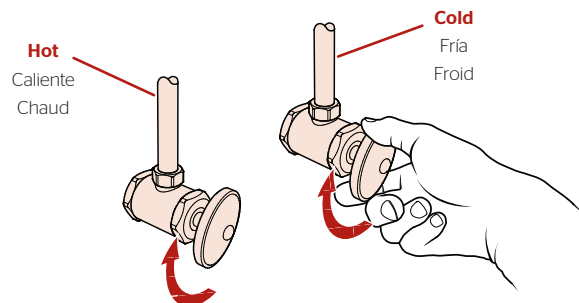

2 Install Faucet Instale el grifo Installer le robinet

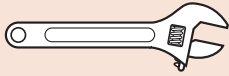

Adjustable Wrench
Llave ajustable
Clé réglable

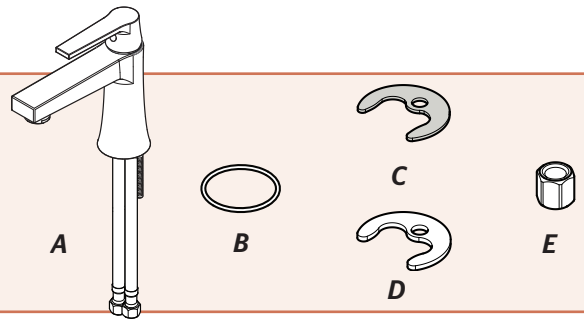

2A

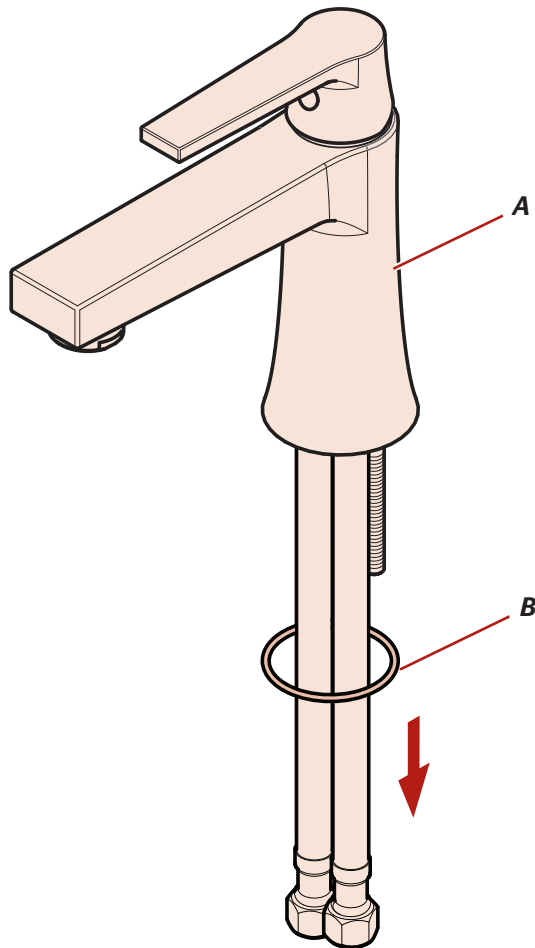

2B

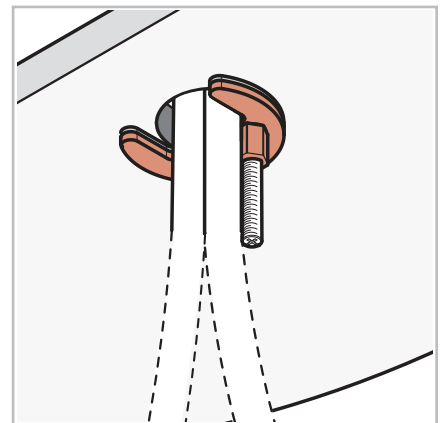
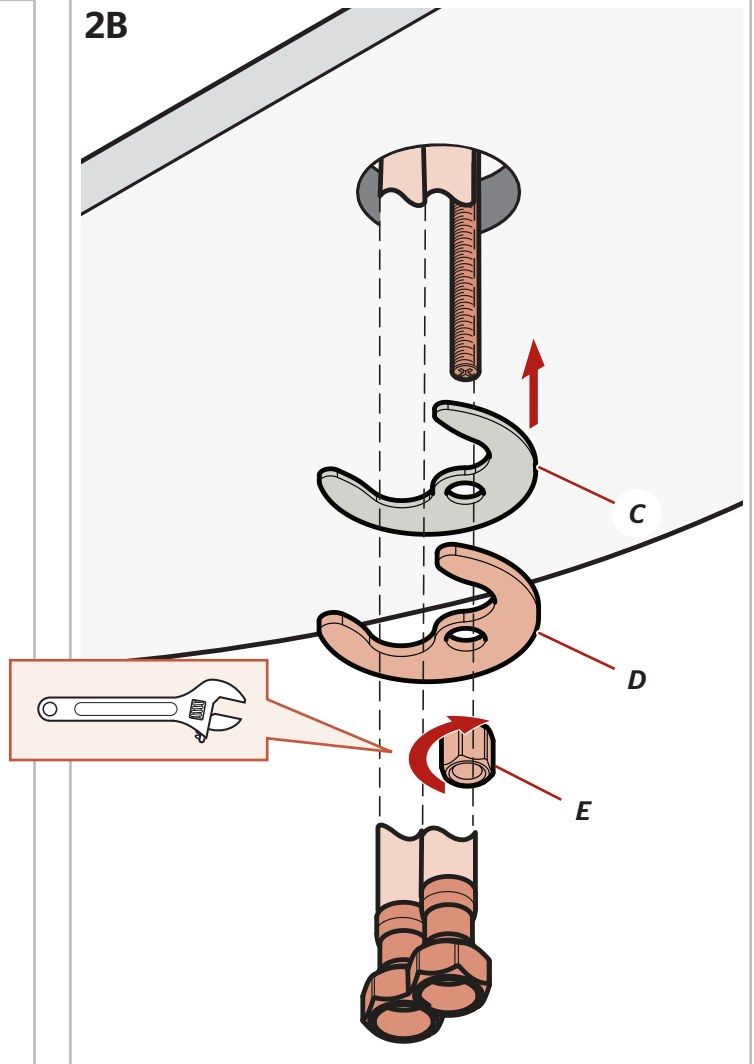

3

Connect Water Supply Lines

Conecte las tuberías de suministro de agua

Raccorder les conduites d'alimentation en eau

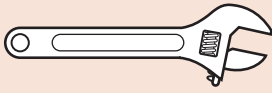

Adjustable Wrenches
Llaves ajustables
Clés à mollette



F (x2)

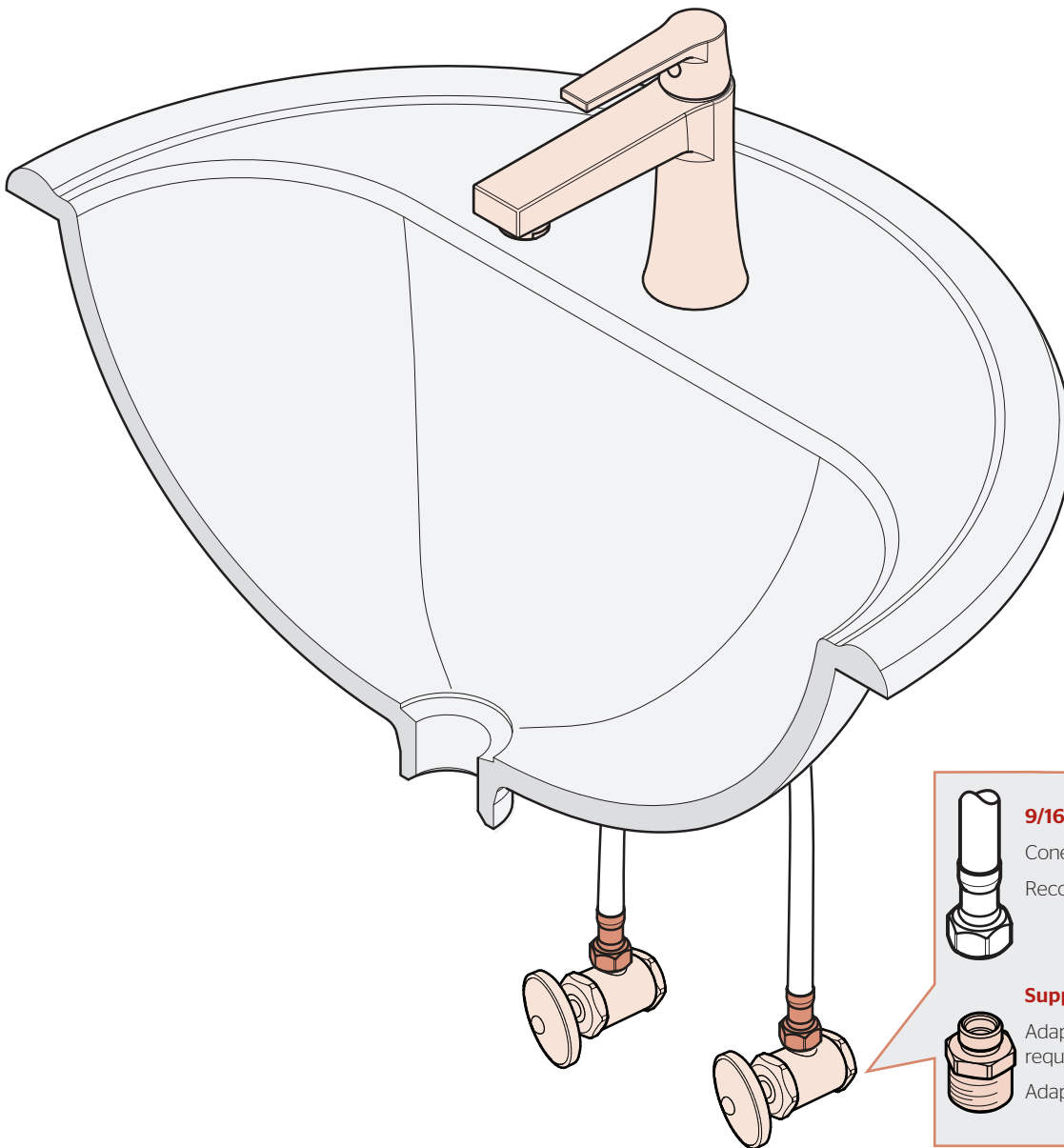

9/16 inch female connection.

Conexión de la hembra de 9/16 pulgada.

Reccordement de femelle de 9/16 pouce.

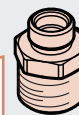

Supplied adapter may be required.

Adaptador suministrado puede ser requerida.

Adaptateur fourni peut être nécessaire.

5 Turn On Water & Confirm Proper Installation

Active el suministro de agua y confirme que la instalación está adecuadamente efectuada

Ouvrez l'eau et confirmez que l'installation est correcte



6 Flush the faucet before using

Limpie el grifo con un chorro de agua antes de usar

Rincez le robinet avant utilisation

6A Remove Aerator

Retire el aereador
Retirez l'aérateur

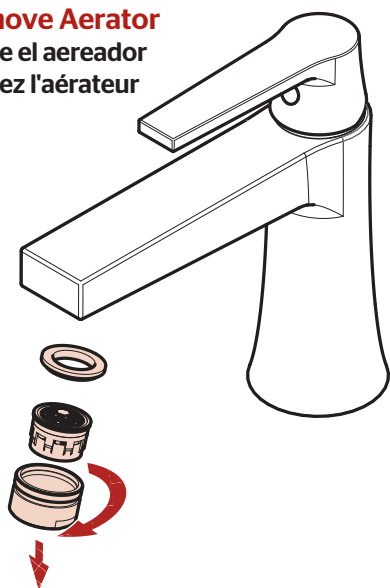

6B Turn On Faucet

Active el grifo
Ouvrez le robinet

Open Slowly

Abra lentamente
Ouvrez lentement



Allow hot & cold water to run for at least 15 seconds each.

Deje correr el agua caliente y fría durante al menos 15 segundos cada una.

Laissez couler l'eau chaude et l'eau froide pendant au moins 15 secondes.

Open
Abierta
Ouvverte

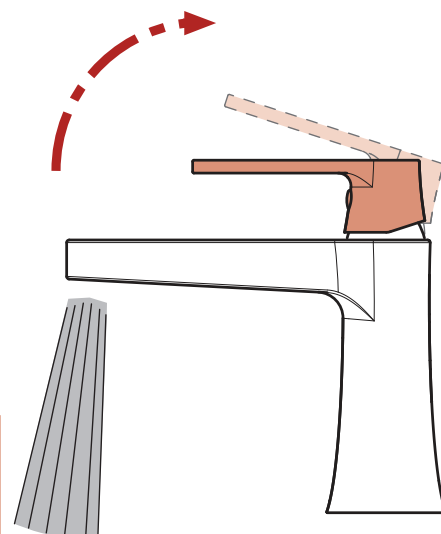

6C

Hot
Caliente
Chaud

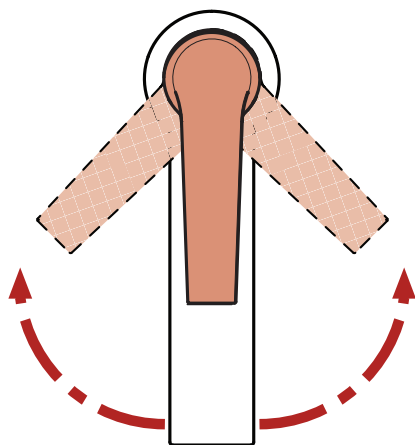

Cold
Fría
Froid

6D Reinstall Aerator

Reinstale el aereador
Réinstallez l'aérateur

Hand Tighten
Apriete con la mano
Serrez manuellement

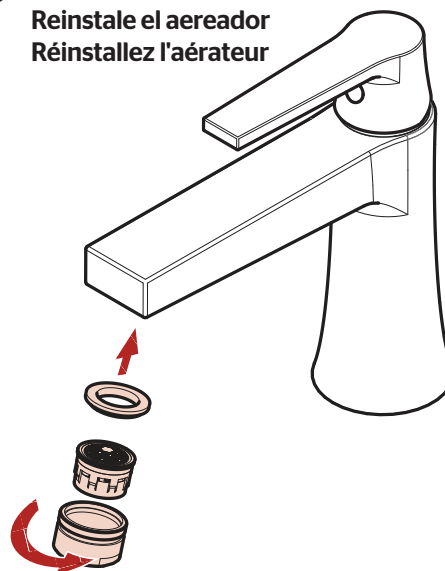

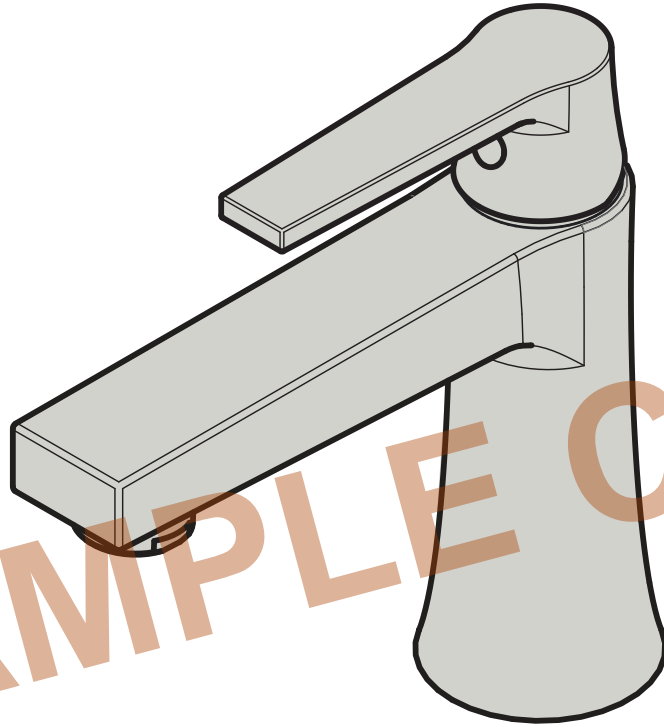

SAMPLE COPY

For Warranty & Care Information or Ordering Replacement Parts:

Para información sobre la garantía y el mantenimiento o para ordenar piezas de repuesto:

Pour renseignements sur la garantie et l'entretien ou pour commander des pièces de rechange:

PfISTER

1-800-340-7608

pfisterfaucets.com/international